

# Rotations (A)

Draw the rotated image.

Rotate  $90^\circ$  clockwise about  $(0, 0)$ .

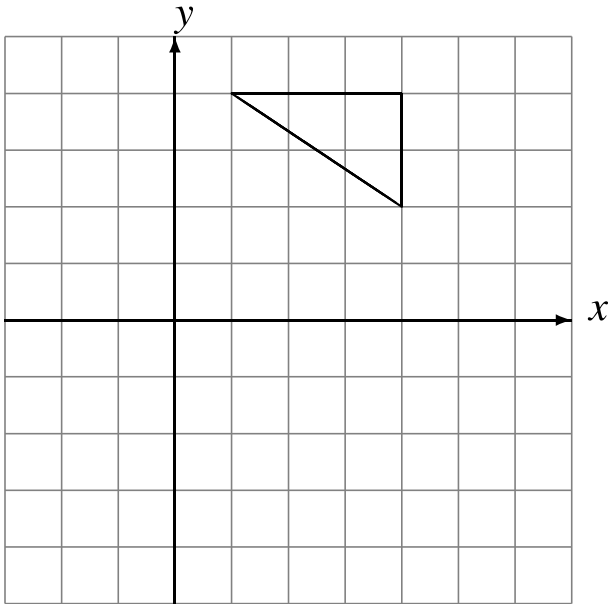

Rotate  $90^\circ$  clockwise about  $(0, 0)$ .

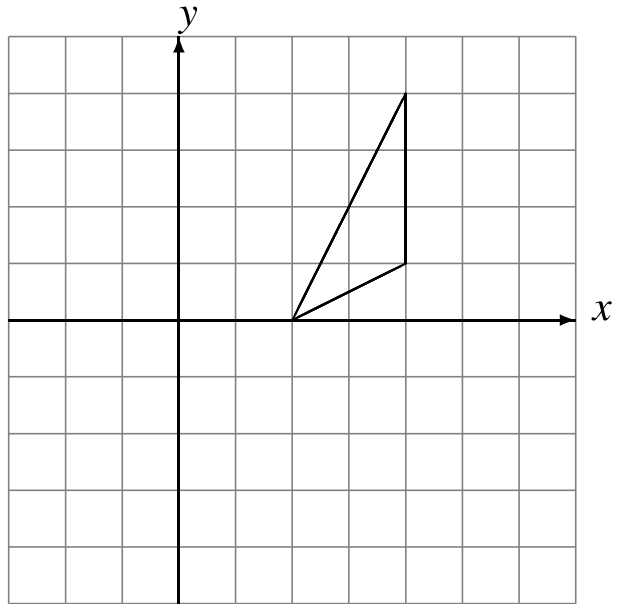

Rotate  $90^\circ$  clockwise about  $(0, 0)$ .

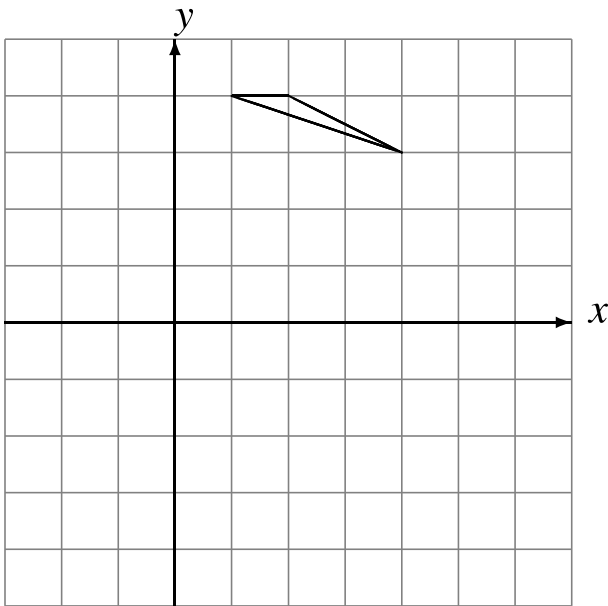

Rotate  $90^\circ$  counterclockwise about  $(0, 0)$ .

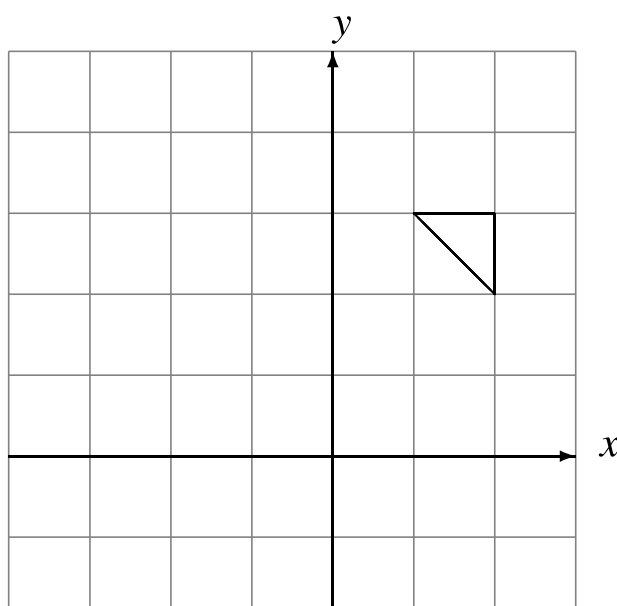

# Rotations (B)

Draw the rotated image.

Rotate  $180^\circ$  about  $(0, 0)$ .

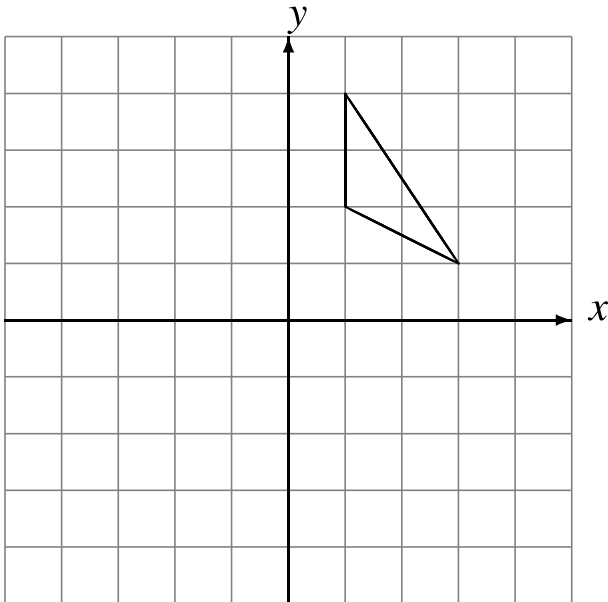

Rotate  $180^\circ$  about  $(0, 0)$ .

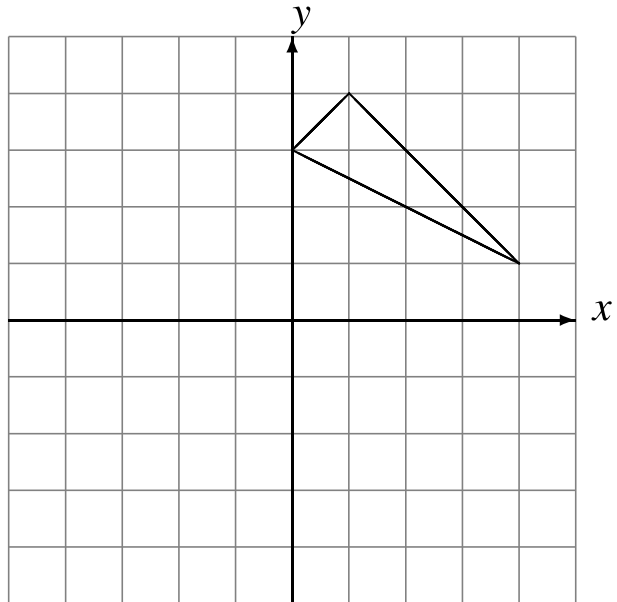

Rotate  $90^\circ$  counterclockwise about  $(0, 0)$ .

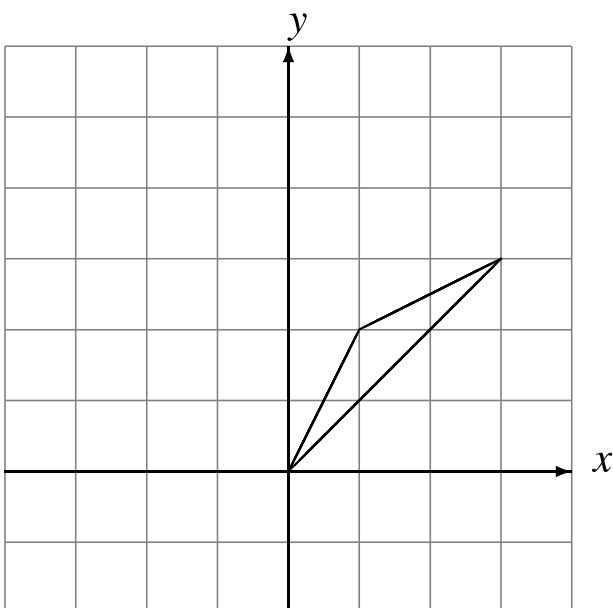

Rotate  $180^\circ$  about  $(0, 0)$ .

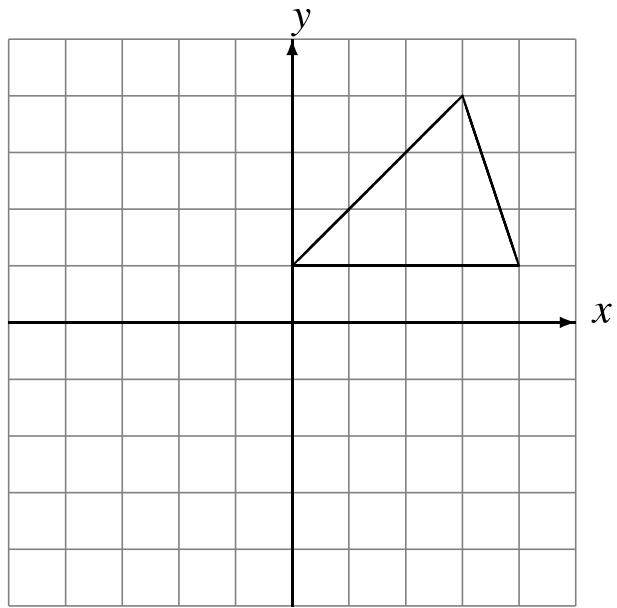

# Rotations (C)

Draw the rotated image.

Rotate  $90^\circ$  counterclockwise about  $(0, 0)$ .

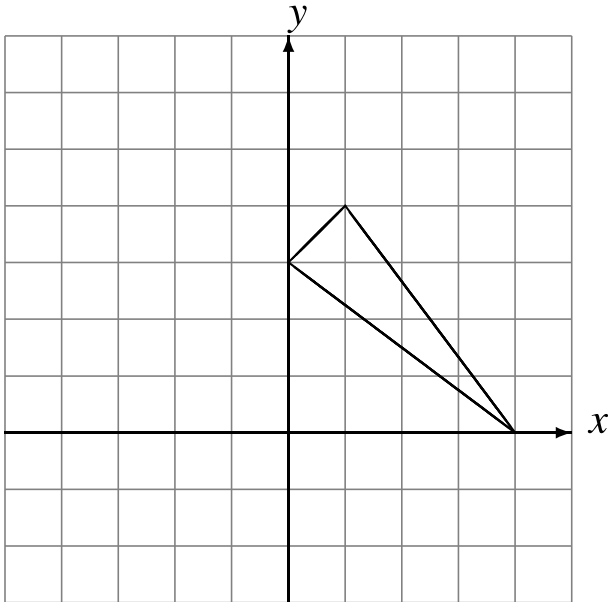

Rotate  $90^\circ$  clockwise about  $(0, 0)$ .

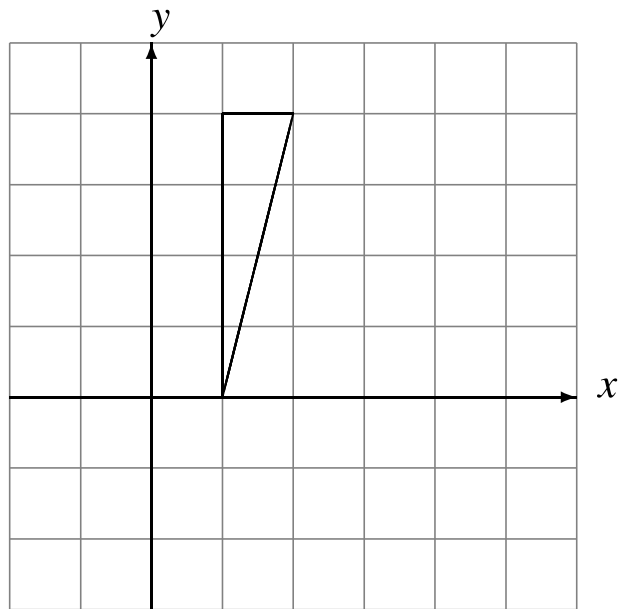

Rotate  $90^\circ$  counterclockwise about  $(0, 0)$ .

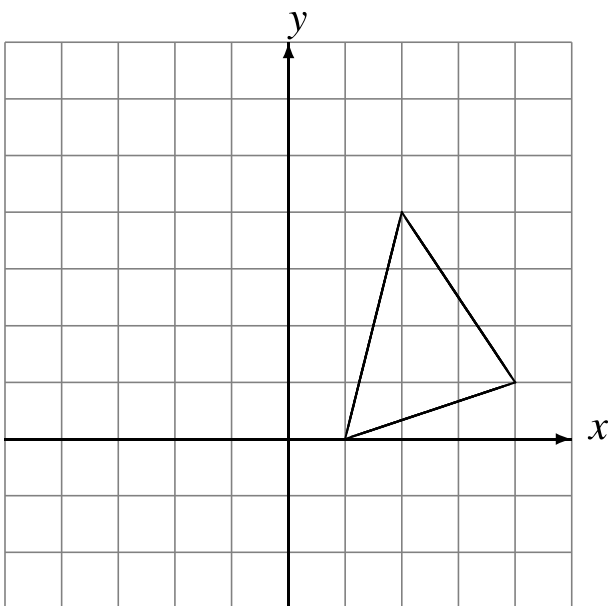

Rotate  $90^\circ$  counterclockwise about  $(0, 0)$ .

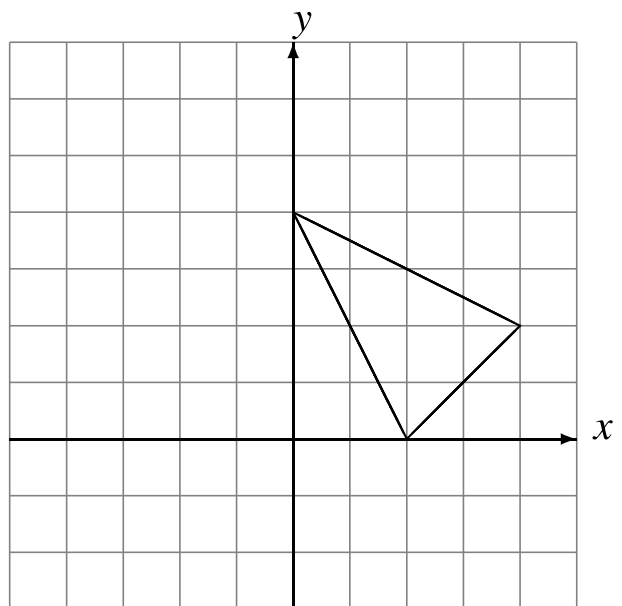

# Rotations (D)

Draw the rotated image.

Rotate  $180^\circ$  about  $(0, 0)$ .

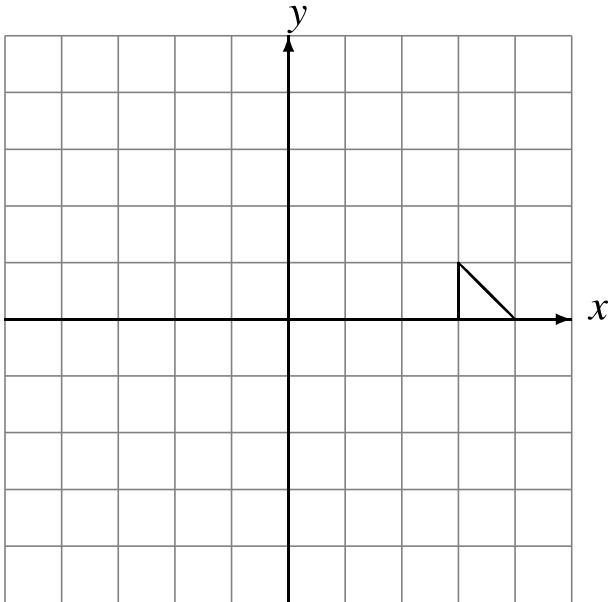

Rotate  $90^\circ$  clockwise about  $(0, 0)$ .

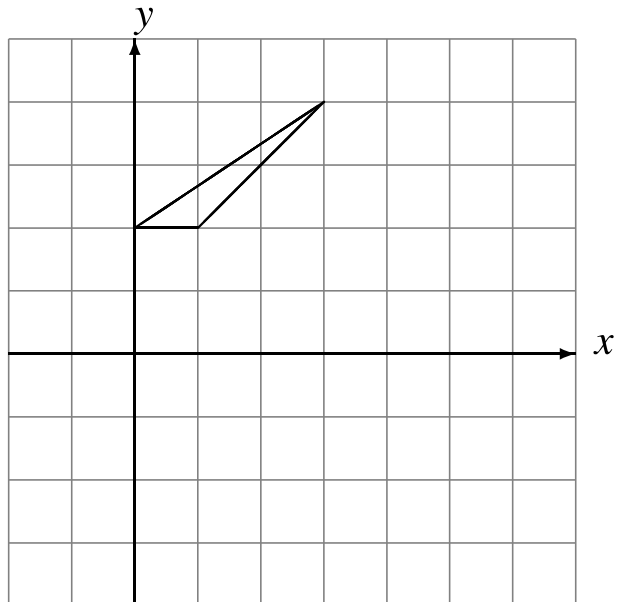

Rotate  $90^\circ$  counterclockwise about  $(0, 0)$ .

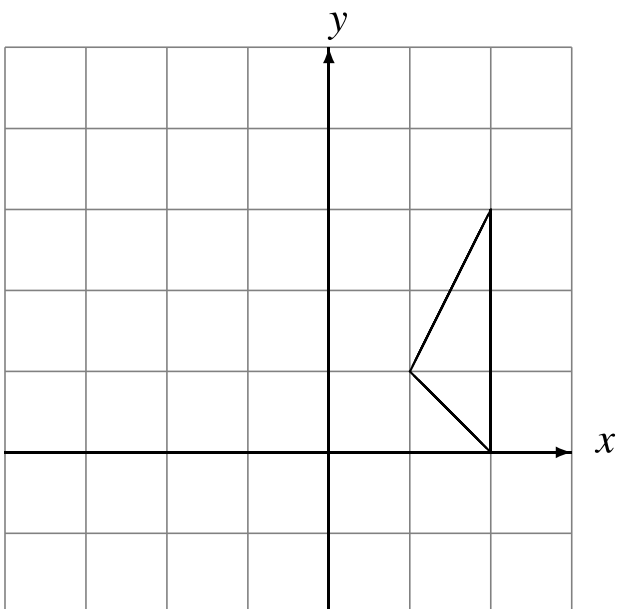

Rotate  $90^\circ$  clockwise about  $(0, 0)$ .

