

Translations (A)

Draw each translated image.

Translate by $(-2, -3)$.

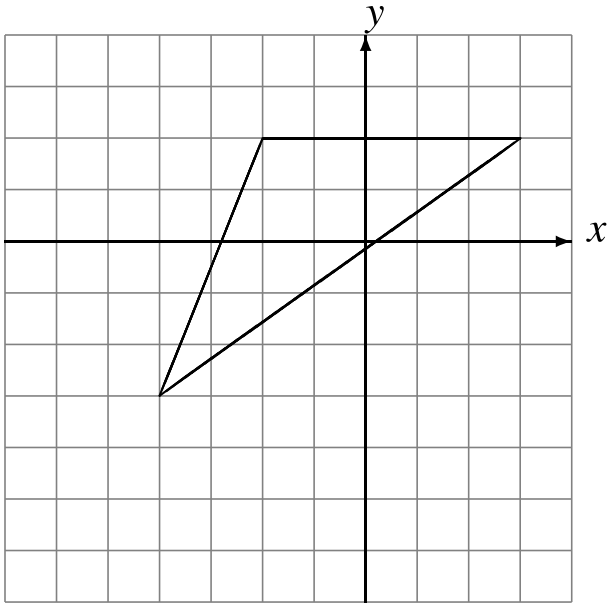

Translate by $(-1, 3)$.

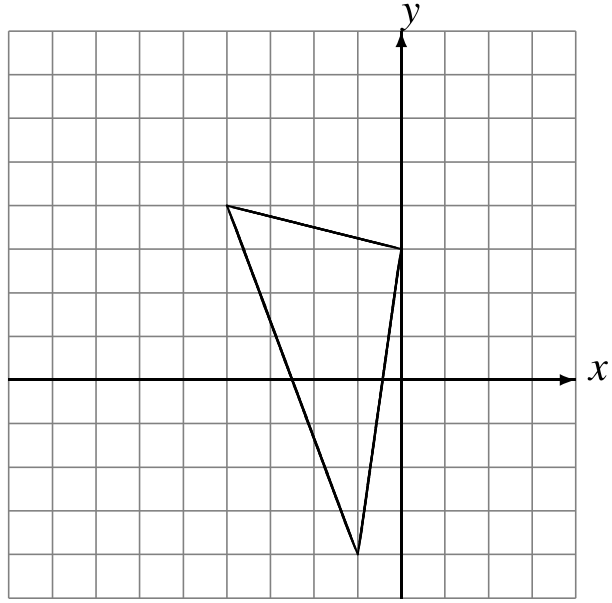

Translate by $(2, 2)$.

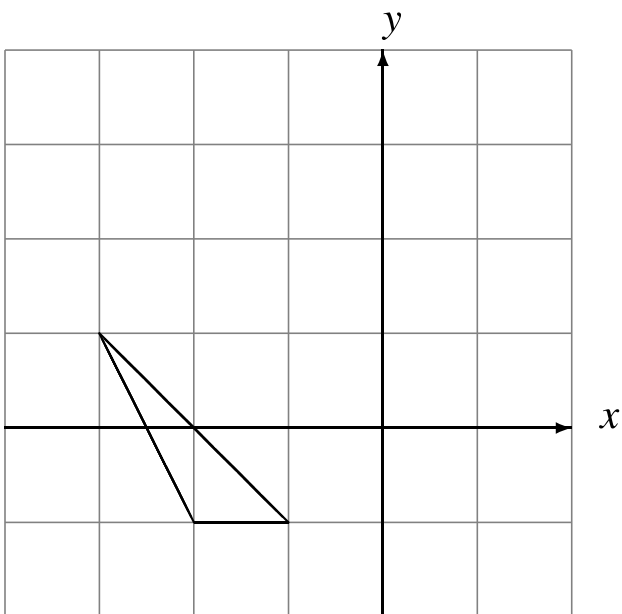

Translate by $(-3, 2)$.

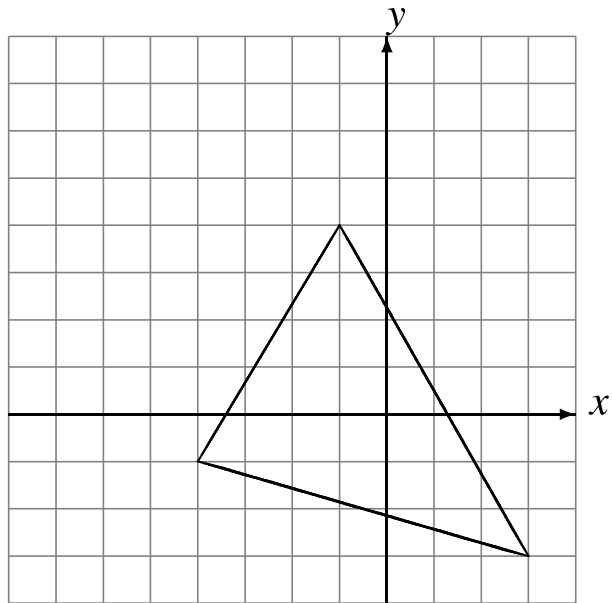

Translations (B)

Draw each translated image.

Translate by $(1, 2)$.

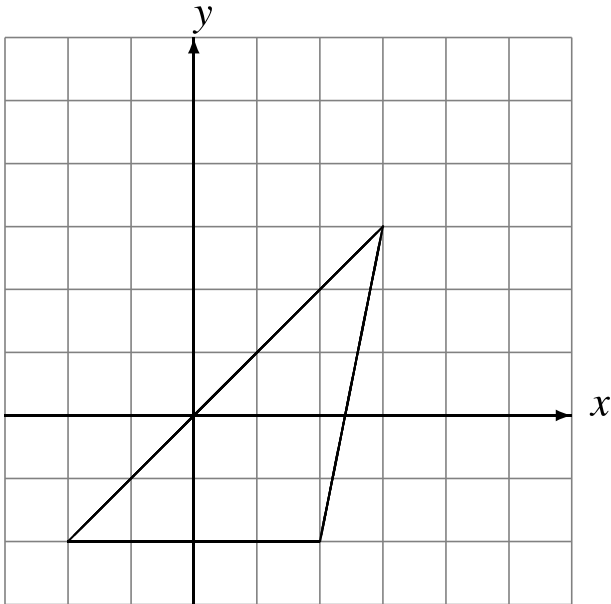

Translate by $(-3, -3)$.

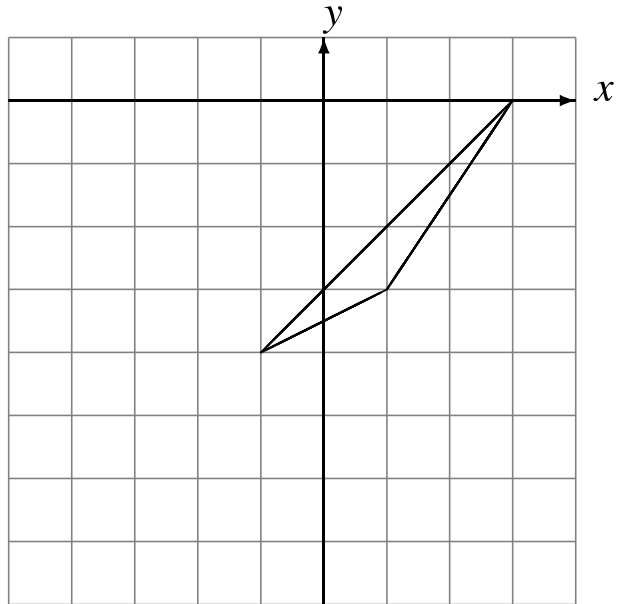

Translate by $(3, 2)$.

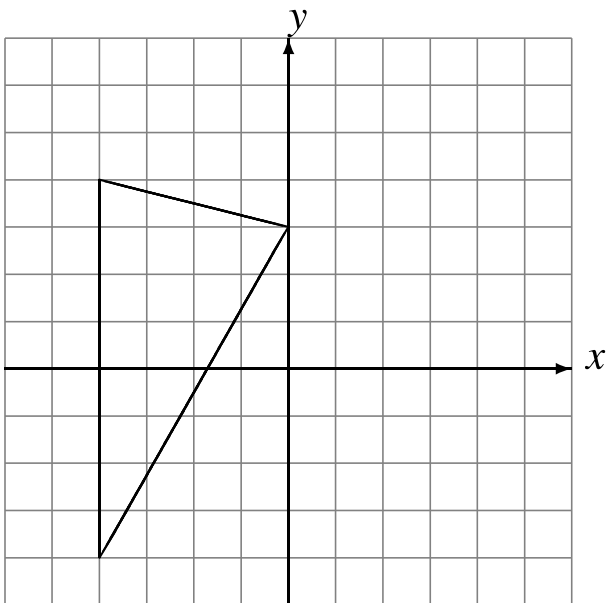

Translate by $(1, 1)$.

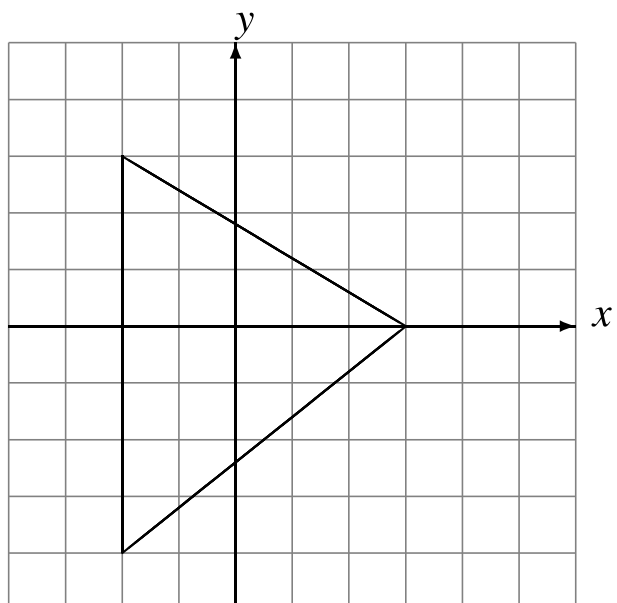

Translations (C)

Draw each translated image.

Translate by $(-1, -1)$.

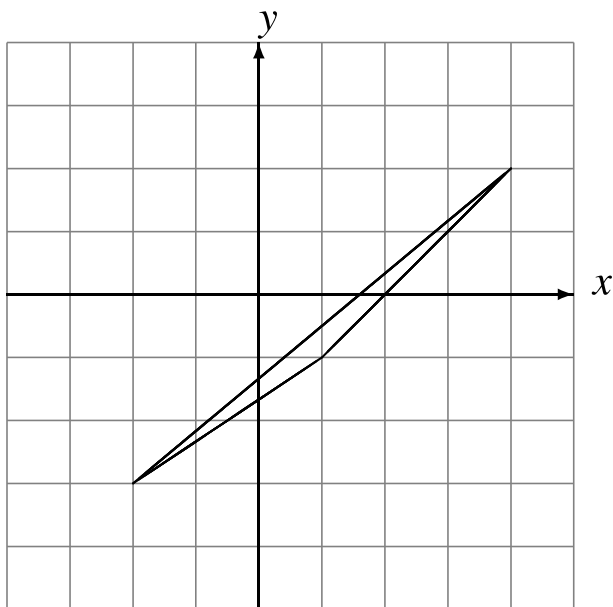

Translate by $(-3, -2)$.

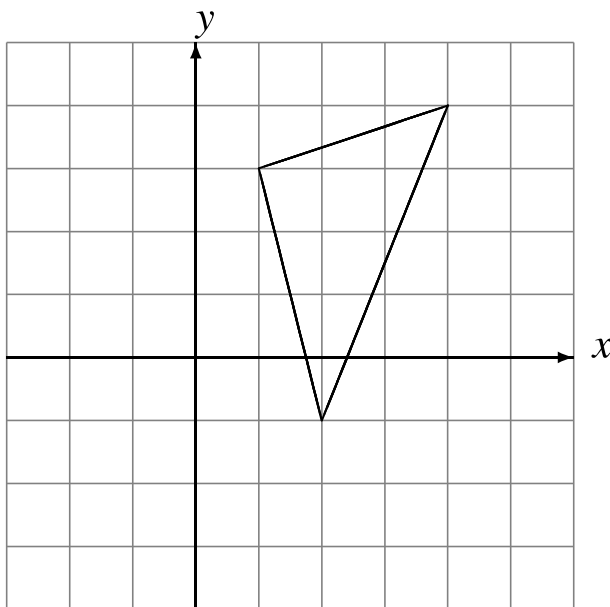

Translate by $(2, 2)$.

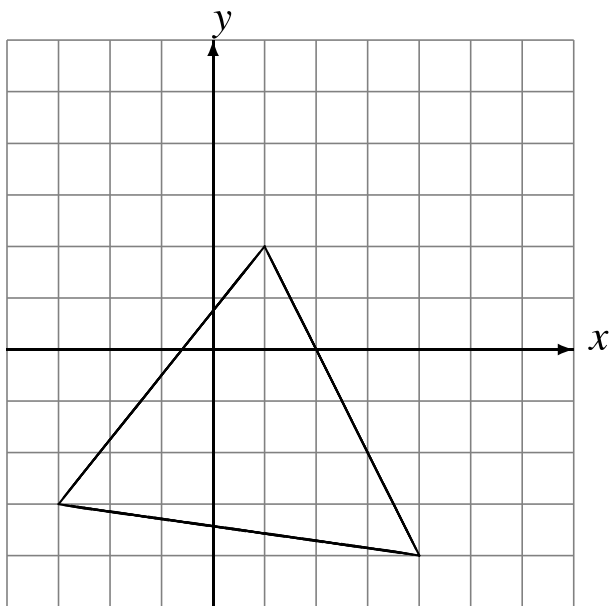

Translate by $(0, 3)$.

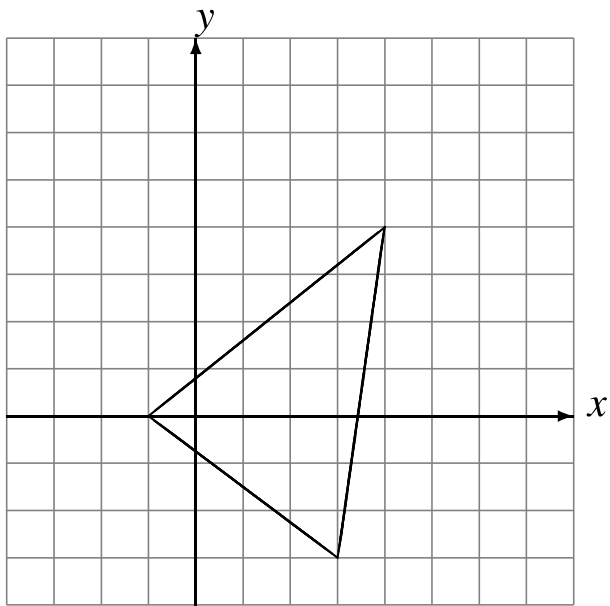

Translations (D)

Draw each translated image.

Translate by $(-3, 3)$.

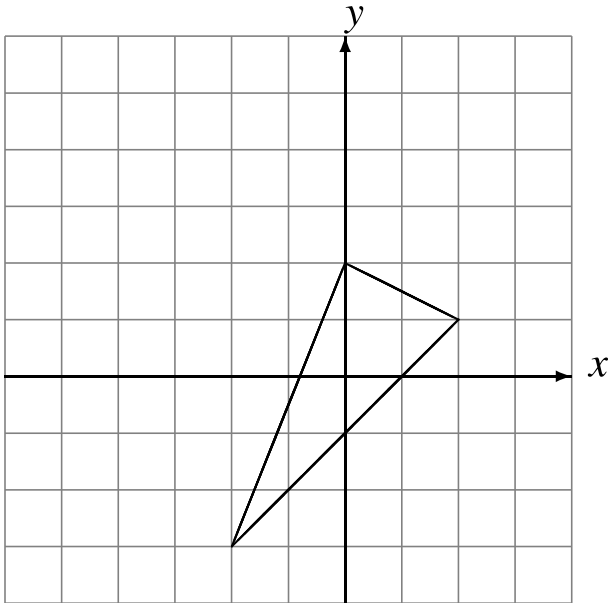

Translate by $(-2, 2)$.

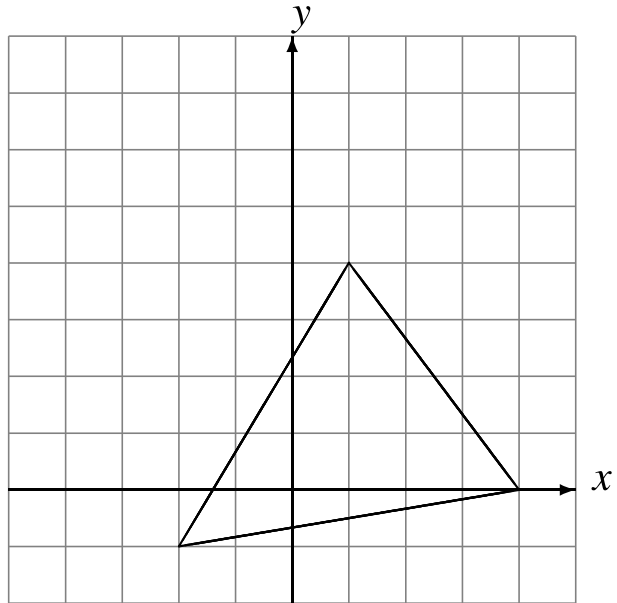

Translate by $(1, -1)$.

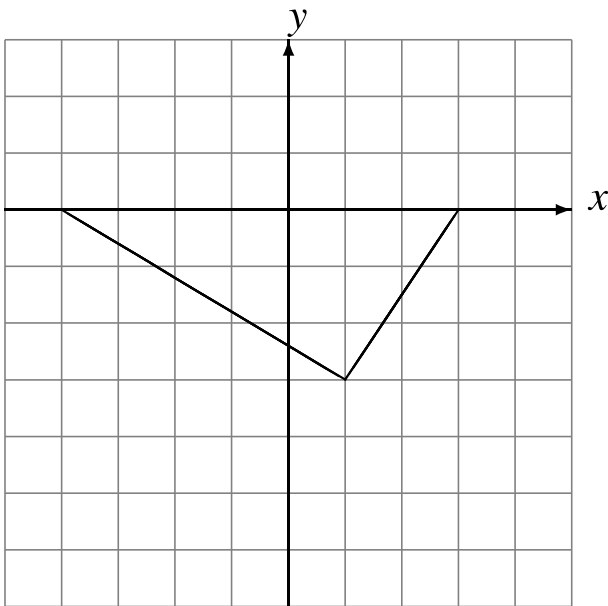

Translate by $(1, -2)$.

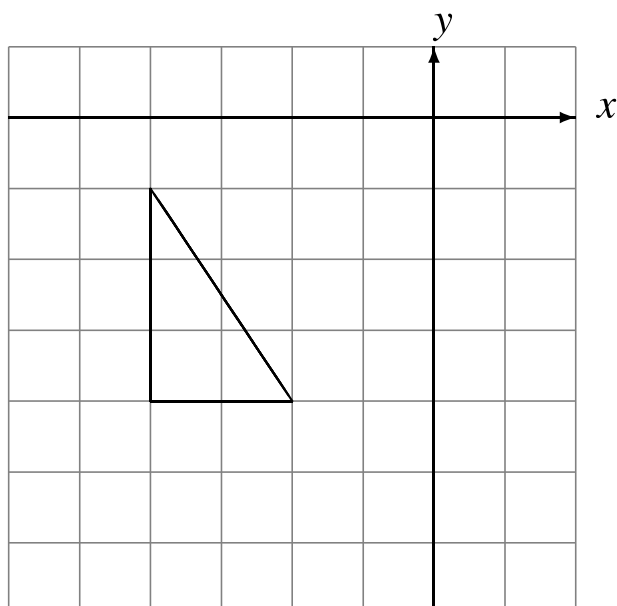

Translations (A)

Draw the intermediate and translated images.

Translate by $(1, -3)$.
Translate by $(2, -6)$.

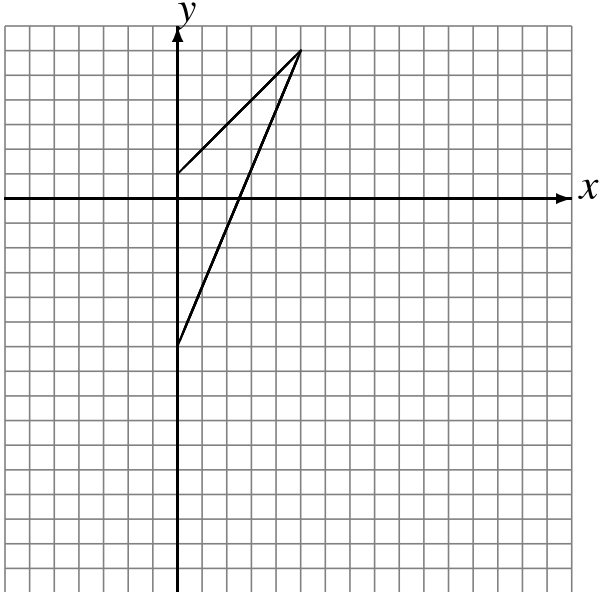

Translate by $(6, 6)$.
Translate by $(-5, -2)$.

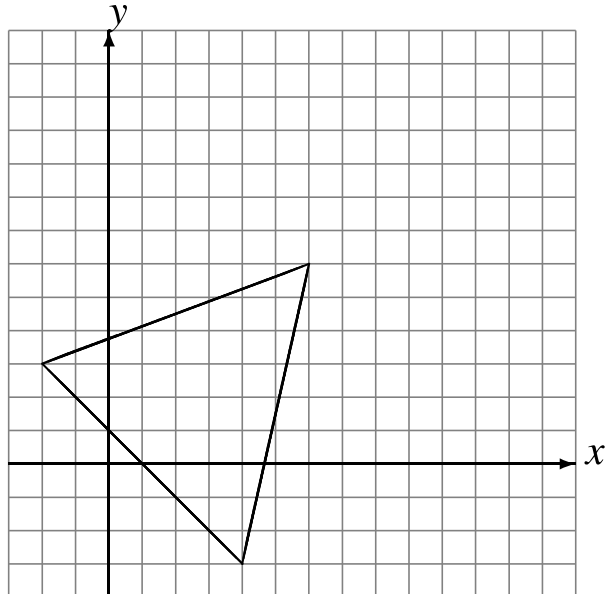

Translate by $(2, 5)$.
Translate by $(1, 3)$.

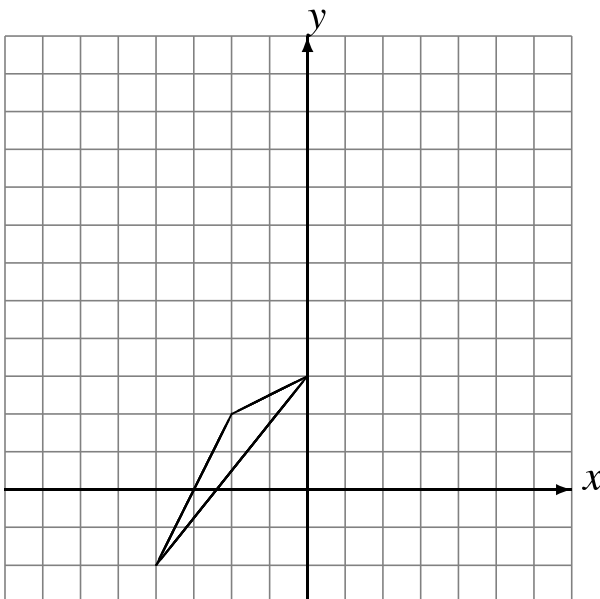

Translate by $(-1, 2)$.
Translate by $(6, -1)$.

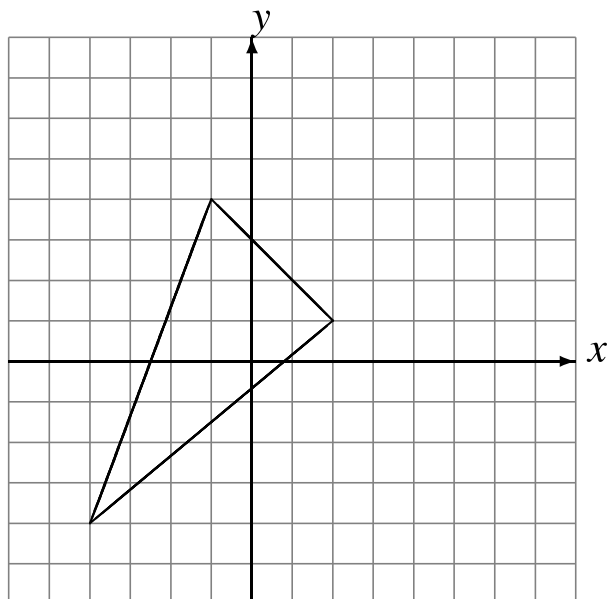

Translations (B)

Draw the intermediate and translated images.

Translate by $(6, -2)$.
Translate by $(3, 5)$.

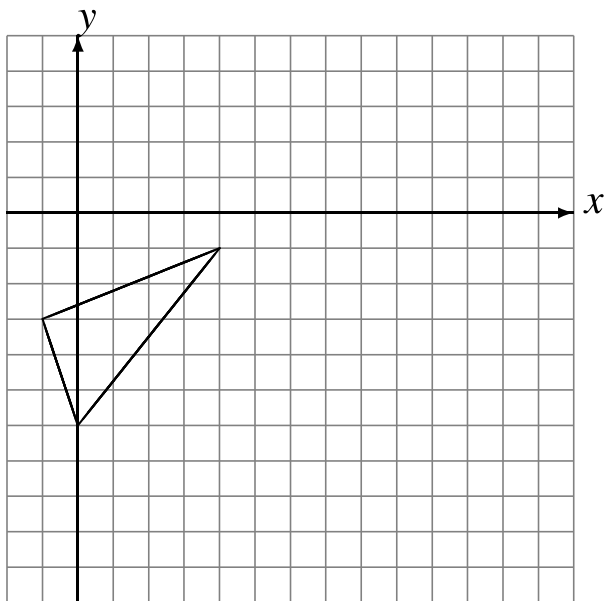

Translate by $(-6, -4)$.
Translate by $(6, 6)$.

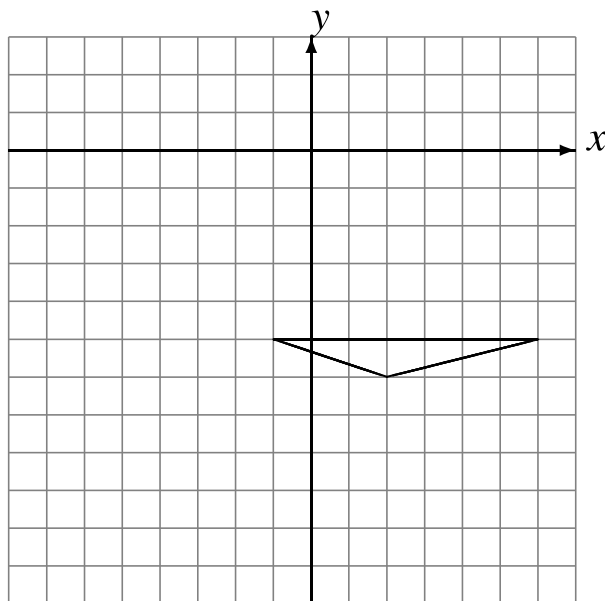

Translate by $(-2, -2)$.
Translate by $(-3, 6)$.

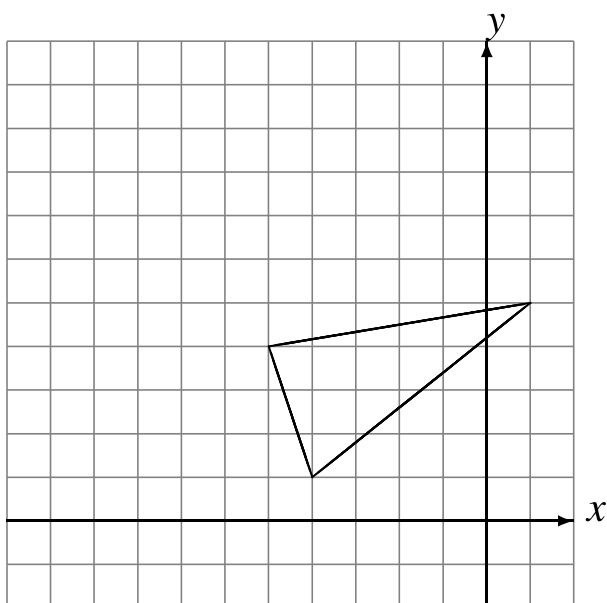

Translate by $(-6, 1)$.
Translate by $(5, -2)$.

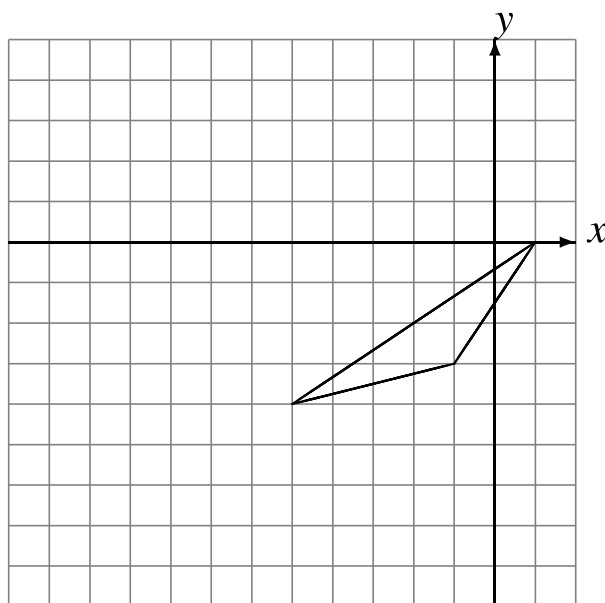

Translations (C)

Draw the intermediate and translated images.

Translate by $(4, -4)$.
Translate by $(-3, 5)$.

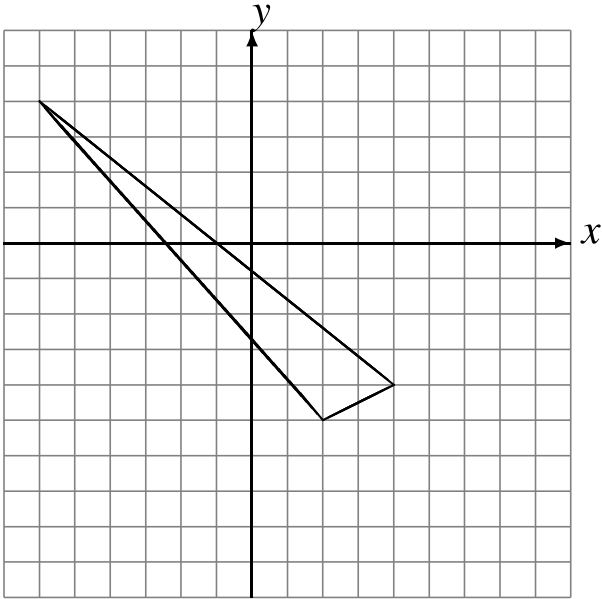

Translate by $(4, 3)$.
Translate by $(0, 4)$.

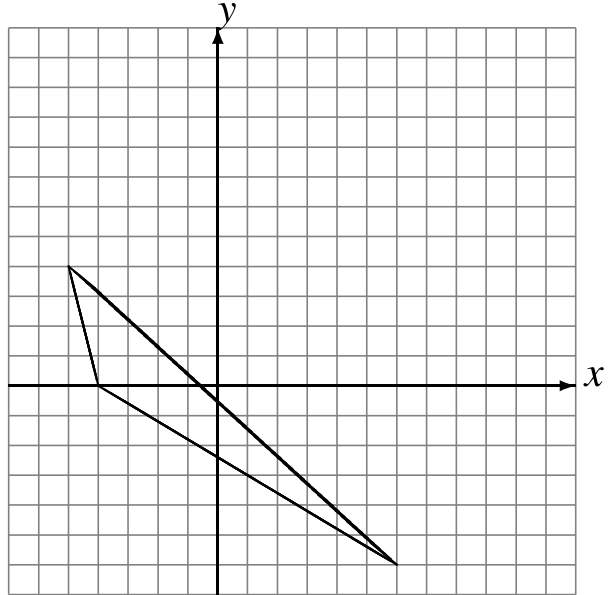

Translate by $(2, 5)$.
Translate by $(3, -2)$.

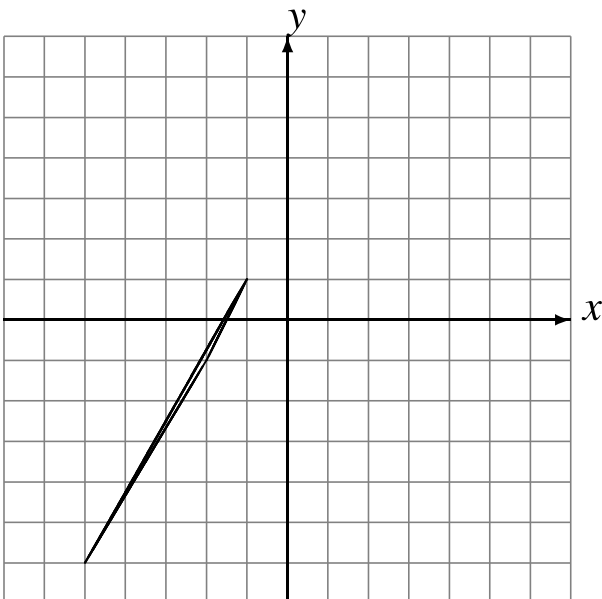

Translate by $(-3, 5)$.
Translate by $(-1, 2)$.

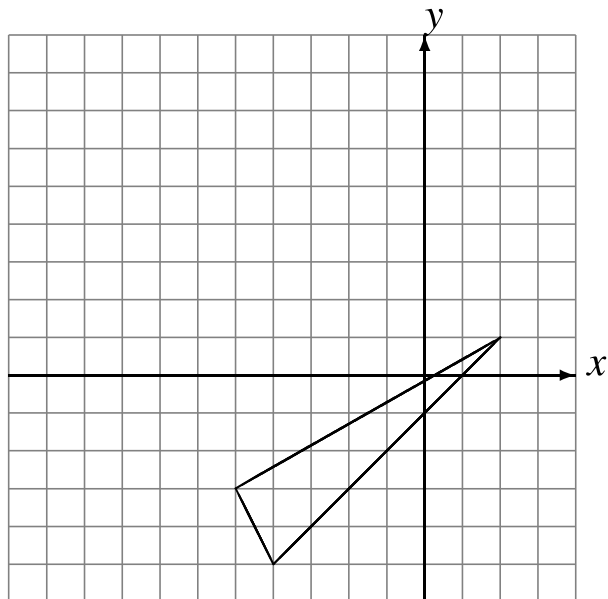

Translations (D)

Draw the intermediate and translated images.

Translate by $(1, 0)$.
Translate by $(0, -2)$.

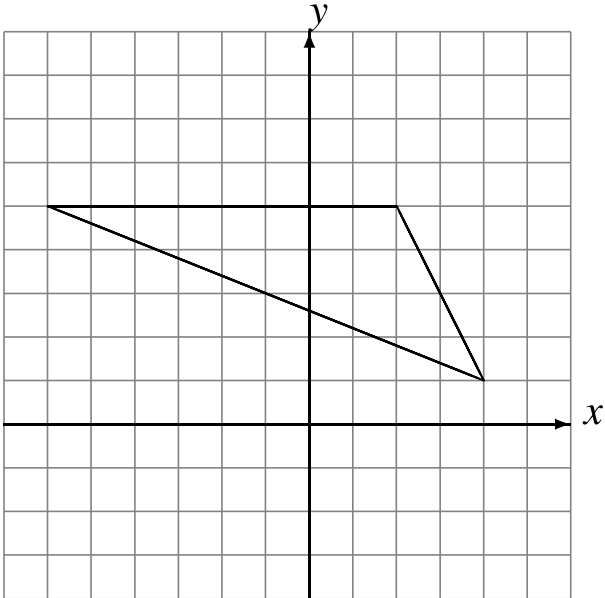

Translate by $(5, 4)$.
Translate by $(-4, 0)$.

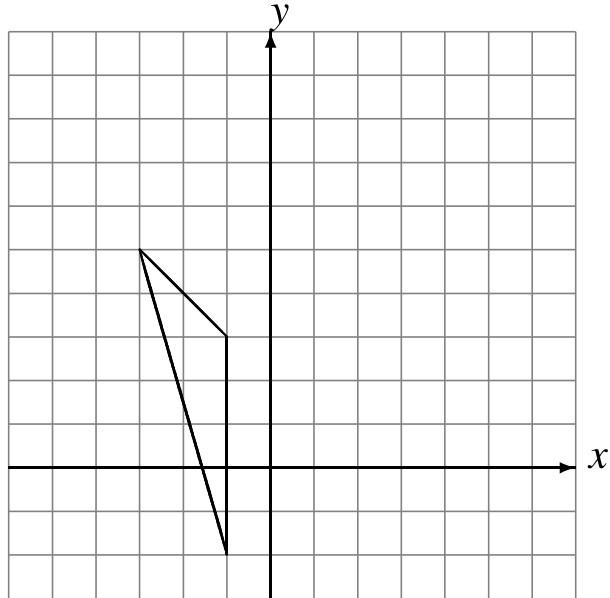

Translate by $(6, 3)$.
Translate by $(-4, 3)$.

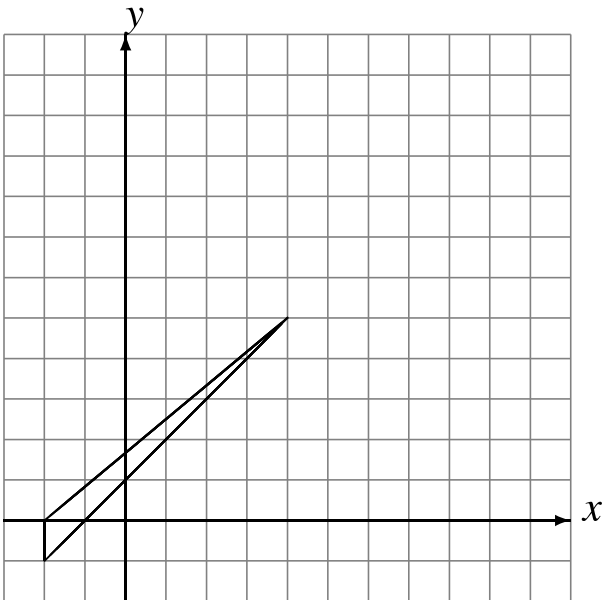

Translate by $(4, -6)$.
Translate by $(1, 4)$.

